

nástroje pro frézování



tools for milling



**VELKOOBCHOD
NÁSTROJI, NÁŘADÍM
s.r.o. A STROJI**

VÁLCOVÁ CYLINDER

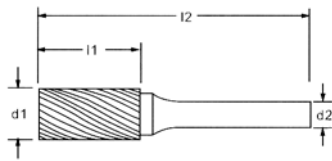
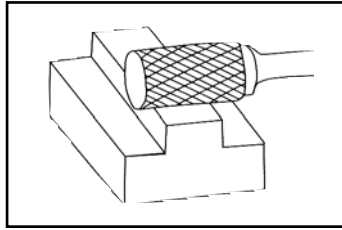

| Označení Item No. | d1 | d2 | l1 | l2 | PC Kč | Price EUR |
|----------------------|----|----|----|----|----------|--------------|
| A0314T03 | 3 | 3 | 14 | 38 | 110 | 3,43 |
| A0413T03 | 4 | 3 | 13 | 52 | 168 | 5,6 |
| A0513T03 | 5 | 3 | 13 | 52 | 176 | 5,87 |
| A0613T03 | 6 | 3 | 13 | 53 | 169 | 5,63 |
| A0618T06 | 8 | 6 | 18 | 63 | 176 | 5,87 |
| A0818T06 | 8 | 6 | 18 | 63 | 203 | 6,75 |
| A1020T06 | 10 | 6 | 20 | 65 | 248 | 8,27 |
| A1225T06 | 12 | 6 | 25 | 70 | 315 | 10,51 |
| A1625T06 | 16 | 6 | 25 | 70 | 530 | 17,68 |
| A1925T06 | 19 | 6 | 25 | 70 | 673 | 22,44 |

VÁLCOVÁ S ČELNÍM BŘÍTEM CYLINDER END CUT

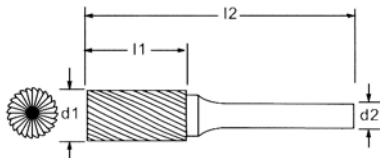
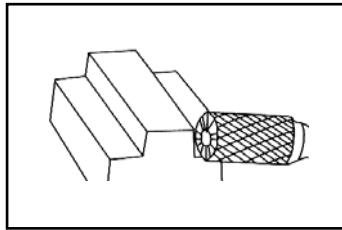

| Označení Item No. | d1 | d2 | l1 | l2 | PC Kč | Price EUR |
|----------------------|----|----|----|----|----------|--------------|
| B0314T03 | 3 | 3 | 14 | 38 | 109 | 3,63 |
| B0613T03 | 6 | 3 | 13 | 52 | 95 | 3,15 |
| B0618T06 | 6 | 6 | 18 | 63 | 199 | 6,64 |
| B0818T06 | 8 | 6 | 18 | 63 | 254 | 8,45 |
| B1020T06 | 10 | 6 | 20 | 65 | 273 | 9,09 |
| B1225T06 | 12 | 6 | 25 | 70 | 397 | 13,23 |
| B1625T06 | 18 | 6 | 25 | 70 | 635 | 21,17 |
| B1925T06 | 19 | 6 | 25 | 70 | 798 | 26,61 |

VÁLCOVÁ S RÁDIUSEM CYLINDER WITH BALL TOP

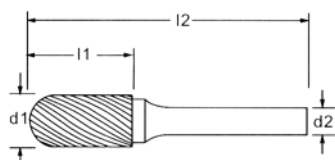
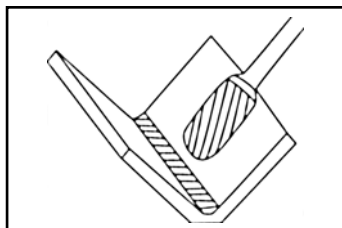

| Označení Item No. | d1 | d2 | l1 | l2 | PC Kč | Price EUR |
|----------------------|----|----|----|----|----------|--------------|
| C0314T03 | 3 | 3 | 14 | 35 | 103 | 3,44 |
| C0512T03 | 5 | 3 | 12 | 52 | 248 | 8,27 |
| C0613T03 | 6 | 3 | 13 | 53 | 169 | 5,63 |
| C0618T06 | 6 | 6 | 18 | 63 | 204 | 6,80 |
| C0818T06 | 8 | 6 | 18 | 63 | 251 | 8,37 |
| C1020T06 | 10 | 6 | 20 | 65 | 277 | 9,23 |
| C1225T06 | 12 | 6 | 25 | 70 | 434 | 14,48 |
| C1625T06 | 16 | 6 | 25 | 70 | 548 | 18,19 |
| C1925T06 | 19 | 6 | 25 | 70 | 675 | 22,50 |

| Označení Item No. | d1 | d2 | l1 | l2 | PC Kč | Price EUR |
|----------------------|----|----|----|----|----------|--------------|
| D0303T03 | 3 | 3 | 3 | 38 | 103 | 3,44 |
| D0403T03 | 4 | 3 | 3 | 43 | 180 | 6,0 |
| D0504T03 | 5 | 3 | 4 | 44 | 248 | 8,27 |
| D0605T06 | 6 | 6 | 5 | 50 | 188 | 6,27 |
| D0807T06 | 8 | 6 | 7 | 52 | 202 | 6,75 |
| D1009T06 | 10 | 6 | 9 | 54 | 227 | 7,57 |
| D1211T06 | 12 | 6 | 11 | 56 | 305 | 10,16 |
| D1614T06 | 16 | 6 | 14 | 60 | 430 | 14,32 |
| D1917T06 | 19 | 6 | 16 | 62 | 522 | 17,41 |

KULOVÁ BALL SHAPE

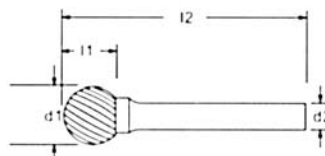
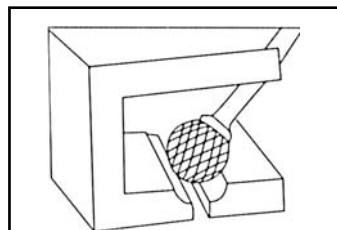

| Označení Item No. | d1 | d2 | l1 | l2 | PC Kč | Price EUR |
|----------------------|----|----|----|----|----------|--------------|
| E0306T03 | 3 | 3 | 6 | 38 | 103 | 3,44 |
| E0508T03 | 5 | 3 | 8 | 48 | 248 | 8,27 |
| E0610T03 | 6 | 3 | 10 | 50 | 169 | 5,63 |
| E0610T06 | 6 | 6 | 10 | 55 | 230 | 7,68 |
| E0813T06 | 8 | 6 | 13 | 58 | 250 | 8,33 |
| E1016T06 | 10 | 6 | 16 | 61 | 277 | 9,23 |
| E1220T06 | 12 | 6 | 20 | 65 | 405 | 13,49 |
| E1625T06 | 16 | 6 | 25 | 70 | 562 | 18,72 |
| E1925T06 | 19 | 6 | 25 | 70 | 754 | 25,15 |

ELIPTICKÁ ELLIPSE

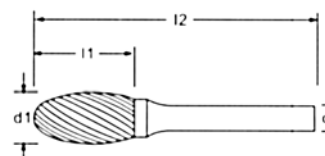
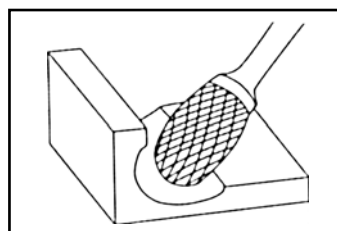

| Označení Item No. | d1 | d2 | l1 | l2 | PC Kč | Price EUR |
|----------------------|----|----|----|----|----------|--------------|
| F0313T03 | 3 | 3 | 13 | 38 | 103 | 3,44 |
| F0513T03 | 5 | 3 | 13 | 50 | 248 | 8,27 |
| F0613T03 | 6 | 3 | 13 | 53 | 169 | 5,63 |
| F0618T06 | 6 | 6 | 18 | 63 | 214 | 7,15 |
| F0818T06 | 8 | 6 | 18 | 63 | 227 | 7,56 |
| F1020T06 | 10 | 6 | 20 | 65 | 270 | 8,99 |
| F1225T06 | 12 | 6 | 25 | 70 | 399 | 13,31 |
| F1625T06 | 16 | 6 | 25 | 70 | 552 | 18,40 |
| F1925T06 | 19 | 6 | 25 | 70 | 726 | 24,19 |
| F1932T06 | 19 | 6 | 32 | 77 | 799 | 26,63 |

STROMEČKOVÁ S RÁDIUSEM ARC CYLINDER WITH BALL TOP

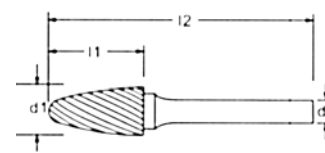
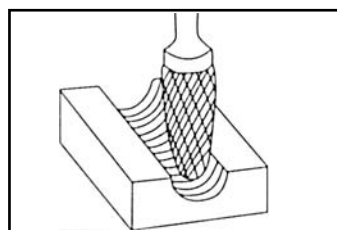

STROMEČKOVÁ SE ŠPIČKOU ARC CYLINDER WITH SHARP TOP

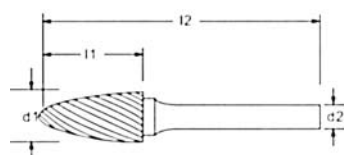
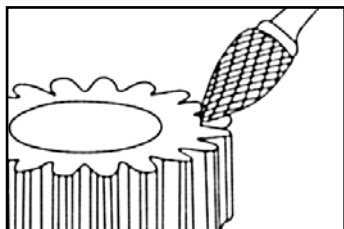

| Označení Item No. | d1 | d2 | l1 | l2 | PC Kč | Price EUR |
|----------------------|----|----|----|----|----------|--------------|
| G0313T03 | 3 | 3 | 13 | 38 | 103 | 3,44 |
| G0613T03 | 6 | 3 | 13 | 53 | 169 | 5,63 |
| G0618T06 | 6 | 6 | 18 | 63 | 214 | 7,15 |
| G0818T06 | 8 | 6 | 18 | 63 | 260 | 8,67 |
| G0820T06 | 8 | 6 | 20 | 65 | 270 | 9,00 |
| G1020T06 | 10 | 6 | 20 | 65 | 288 | 9,60 |
| G1220T06 | 12 | 6 | 20 | 65 | 392 | 13,07 |
| G1225T06 | 12 | 6 | 25 | 70 | 392 | 13,07 |
| G1625T06 | 16 | 6 | 25 | 70 | 545 | 18,16 |

PLAMĚNKOVÁ FLAME

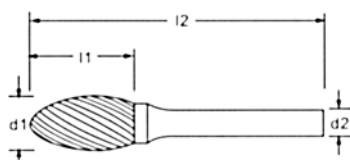
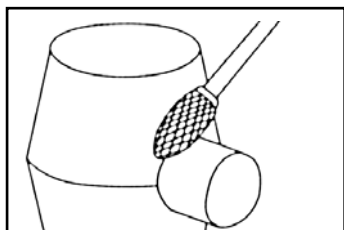

| Označení Item No. | d1 | d2 | l1 | l2 | PC Kč | Price EUR |
|----------------------|----|----|----|----|----------|--------------|
| H0307T03 | 3 | 3 | 7 | 47 | 143 | 4,77 |
| H0618T06 | 6 | 6 | 18 | 63 | 162 | 5,40 |
| H0820T06 | 8 | 6 | 20 | 65 | 283 | 9,44 |
| H1025Z06 | 10 | 6 | 25 | 70 | 340 | 11,33 |
| H1232T06 | 12 | 6 | 32 | 75 | 578 | 19,25 |
| H1636T06 | 16 | 6 | 36 | 81 | 798 | 26,61 |
| H1941T06 | 19 | 6 | 41 | 86 | 1015 | 33,84 |

ZÁHLUBNÍK 60° CONE 60°

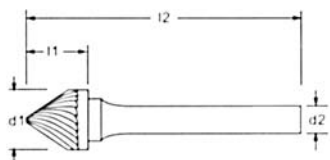
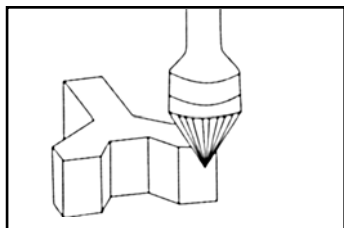

| Označení Item No. | d1 | d2 | l1 | l2 | PC Kč | Price EUR |
|----------------------|----|----|------|----|----------|--------------|
| J0303T03 | 3 | 3 | 2,5 | 38 | 103 | 3,44 |
| J0605T06 | 6 | 6 | 5 | 50 | 162 | 5,40 |
| J0807T06 | 8 | 6 | 7 | 52 | 227 | 7,56 |
| J1008T06 | 10 | 6 | 8 | 54 | 246 | 8,21 |
| J1210T06 | 12 | 6 | 10 | 55 | 300 | 10,00 |
| J1614T06 | 16 | 6 | 14 | 59 | 399 | 13,31 |
| J1916T06 | 19 | 6 | 16,5 | 65 | 525 | 17,49 |

| Označení Item No. | d1 | d2 | l1 | l2 | PC Kč | Price EUR |
|----------------------|---------|----|----|----|----------|--------------|
| L0313T03 | 3(14°) | 3 | 13 | 38 | 91 | 3,02 |
| L0513T03 | 5(14°) | 3 | 13 | 38 | 248 | 8,27 |
| L0612T03 | 6(14°) | 3 | 12 | 38 | 95 | 3,15 |
| L0619T03 | 6(14°) | 3 | 19 | 38 | 108 | 3,60 |
| L0612T06 | 6(14°) | 6 | 12 | 38 | 162 | 5,40 |
| L0616T06 | 6(14°) | 6 | 16 | 61 | 219 | 7,31 |
| L0822T06 | 8(14°) | 6 | 22 | 67 | 302 | 10,05 |
| L1027T06 | 10(14°) | 6 | 27 | 72 | 422 | 14,05 |
| L1230T06 | 12(14°) | 6 | 30 | 75 | 754 | 25,12 |
| L1630T06 | 16(14°) | 6 | 30 | 75 | 1096 | 36,53 |
| L1938T06 | 19(14°) | 6 | 38 | 83 | 1205 | 40,19 |

KUŽELOVÁ S RÁDIUSEM CONICAL ROUND NOSE

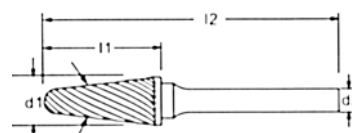
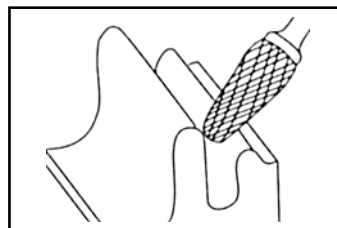

| Označení Item No. | d1 | d2 | l1 | l2 | PC Kč | Price EUR |
|----------------------|----------|----|------|----|----------|--------------|
| M0311T03 | 3(14°) | 3 | 11 | 38 | 91 | 3,02 |
| M0316T03 | 3(7°) | 3 | 16 | 38 | 103 | 3,44 |
| M0513T03 | 5(14°) | 3 | 12,7 | 38 | 248 | 8,27 |
| M0613T06 | 6(22°) | 6 | 12,7 | 50 | 169 | 5,63 |
| M0619T06 | 6(14°) | 6 | 19 | 64 | 207 | 6,91 |
| M0818T06 | 8(25°) | 6 | 18 | 63 | 219 | 7,31 |
| M0820T06 | 8(22,6°) | 6 | 20 | 65 | 227 | 7,56 |
| M1016T06 | 9,5(28°) | 6 | 16 | 61 | 346 | 11,52 |
| M1020T06 | 10(25°) | 6 | 20 | 65 | 380 | 12,67 |
| M1225T06 | 12(25°) | 6 | 25 | 70 | 434 | 14,45 |
| M1625T06 | 16(36°) | 6 | 25 | 70 | 578 | 19,25 |

KUŽELOVÁ CONE SHAPE

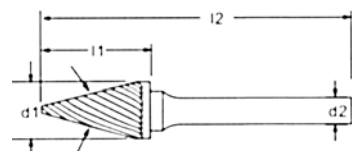
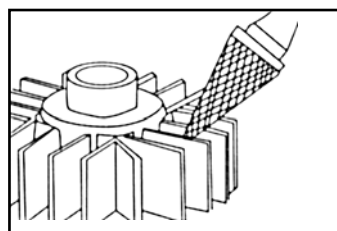

| Označení Item No. | d1 | d2 | l1 | l2 | PC Kč | Price EUR |
|----------------------|----|----|-----|----|----------|--------------|
| K0302T03 | 3 | 3 | 1,5 | 38 | 103 | 3,44 |
| K0603T06 | 6 | 6 | 3 | 48 | 188 | 6,27 |
| K0804T06 | 8 | 6 | 4 | 49 | 207 | 6,90 |
| K1005T06 | 10 | 6 | 4,7 | 50 | 246 | 8,21 |
| K1206T06 | 12 | 6 | 6 | 51 | 300 | 10,00 |
| K1608T06 | 16 | 6 | 8 | 53 | 399 | 13,31 |
| K1910T06 | 19 | 6 | 9,5 | 55 | 525 | 17,49 |

ZÁHLUBNÍK 90° CONE 90°

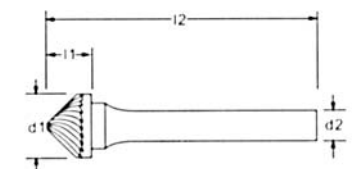
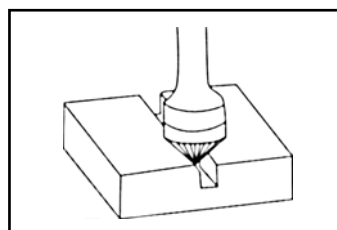

OBRÁCENÝ KUŽEL INVERTED CONE

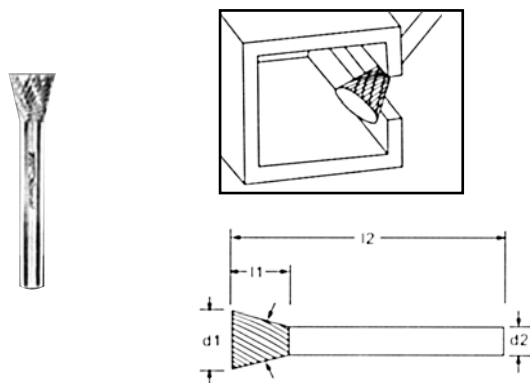

| Označení Item No. | d1 | d2 | l1 | l2 | PC Kč | Price EUR |
|----------------------|-----------|----|------|----|----------|--------------|
| N0303T03 | 3(10°) | 3 | 3 | 40 | 103 | 3,44 |
| N0304T03 | 3(10°) | 3 | 4 | 40 | 103 | 3,44 |
| N0505T03 | 5(10°) | 3 | 5 | 45 | 248 | 8,27 |
| N0608T06 | 6(10°) | 6 | 8 | 53 | 186 | 6,19 |
| N0606T03 | 6,3(10°) | 3 | 6 | 46 | 209 | 6,96 |
| N1010T06 | 9,5(13°) | 6 | 9,5 | 55 | 221 | 7,35 |
| N1313T06 | 12,7(28°) | 6 | 12,7 | 58 | 431 | 14,37 |
| N1619T06 | 16(20°) | 6 | 19 | 61 | 582 | 19,39 |
| N1916T06 | 19(30°) | 6 | 16 | 61 | 623 | 20,77 |

DISKOVÝ TVAR S RÁDIUSEM DISC TYPE WITH ARC EDGE

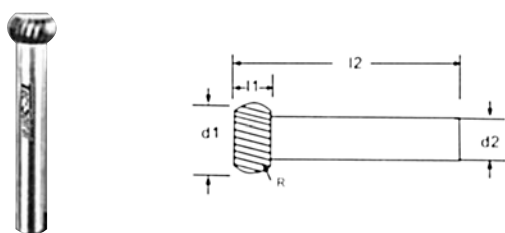

| Označení Item No. | d1 | d2 | l1 | l2 | R | PC Kč | Price EUR |
|----------------------|----|----|----|----|-----|----------|--------------|
| W1603T06 | 16 | 6 | 3 | 45 | 2,5 | 479 | 15,96 |
| W2504T06 | 25 | 6 | 4 | 45 | 4 | 693 | 23,10 |
| W2505T06 | 25 | 6 | 5 | 45 | 4 | 693 | 23,10 |

DISKOVÝ TVAR DISC TYPE

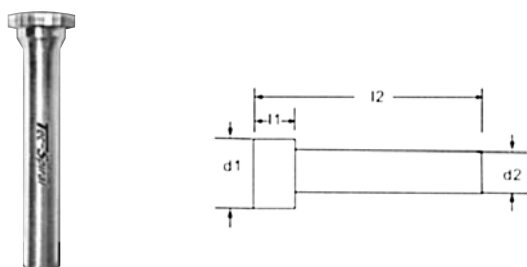

| Označení Item No. | d1 | d2 | l1 | l2 | PC Kč | Price EUR |
|----------------------|----|----|----|----|----------|--------------|
| X1202T06 | 12 | 6 | 2 | 45 | 252 | 8,40 |
| X1602T06 | 16 | 6 | 2 | 45 | 479 | 15,96 |
| X1603T06 | 16 | 6 | 3 | 45 | 479 | 15,96 |
| X2504T06 | 25 | 6 | 4 | 45 | 693 | 23,10 |
| X2505T06 | 25 | 6 | 5 | 45 | 693 | 23,10 |

DISKOVÝ TVAR S 90° ÚHLEM DISC TYPE WITH 90° ANGLE

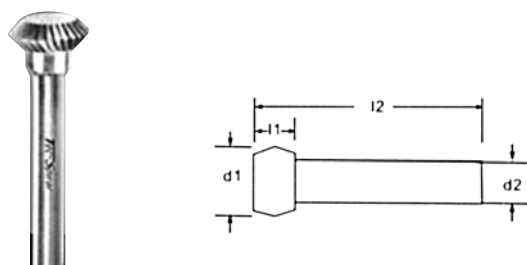

| Označení Item No. | d1 | d2 | l1 | l2 | PC Kč | Price EUR |
|----------------------|----|----|----|----|----------|--------------|
| Y1603T06 | 16 | 6 | 3 | 45 | 479 | 15,96 |
| Y2505T06 | 25 | 6 | 5 | 45 | 693 | 23,10 |



T = X

Y

V

M

W

wide cut - jednoduchý široký břit

single cut - jednoduchý břit

speed way - jemný křížový břit

cheap breaker - s lamačem třísek

double cut - křížový břit

Příklad objednávky (Order):

F1225X06

Fréza stromečková s rádiusem, délka řezné části 12 mm, stopka 6 mm, křížový břit (X)
ARC CYLINDER WITH BALL TOP, d1=12 mm, d2=6mm, double cut (X)

Uvedené ceny jsou platné pro křížový břit (X)

Price - for double cut (X)

VELKOOBCHOD NÁSTROJI, NÁŘADÍM A STROJI



M&V spol. s r.o., ulice 4. května 288, 755 01 VSETÍN

Tel.: 571 411 127-9, 571 484 888, 571 411 140, 571 411 618, 571 413 384 Fax: 571 412 241, 571 413 126

www.mav.cz

<http://katalog.mav.cz>

[e-mail: info@mav.cz](mailto:info@mav.cz)



101 16 PRAHA 10
Moskevská 63
tel./fax: 257 210 866
tel./fax: 257 216 003



787 01 ŠUMPERK
Žižkova 1/a
tel., fax: 583 223 836
tel.: 583 213 342



603 00 BRNO
MZLU Pisárecká 11, budova VI-05
tel.: 543 212 255
fax: 543 241 572



386 01 STRAKONICE
Palackého náměstí 102
tel., fax: 383 324 103
tel.: 383 323 327



020 01 PÚCHOV, SR
Vsetínská cesta 1487/9
tel.: +421/42/463 45 46-8
fax: +421/42/463 45 49



460 10 LIBEREC
Vilová 502
tel., fax: 485 150 480
tel.: 482 770 056

nástroje na obrábění otvorů



tools for hole-machining

M&V VELKOORCHOD
NÁSTROJI, NÁŘADÍM
A STROJÍ

nástroje pro soustružení dělení a broušení



tools for turning cutting and grinding

M&V VELKOORCHOD
NÁSTROJI, NÁŘADÍM
A STROJÍ

měřidla



measuring instruments

M&V VELKOORCHOD
NÁSTROJI, NÁŘADÍM
A STROJÍ

závitové nástroje



tools for threading

M&V VELKOORCHOD
NÁSTROJI, NÁŘADÍM
A STROJÍ

nástroje pro frézování



tools for milling

M&V VELKOORCHOD
NÁSTROJI, NÁŘADÍM
A STROJÍ

frézování soustružením VBD



milling turning with indexable inserts

M&V VELKOORCHOD
NÁSTROJI, NÁŘADÍM
A STROJÍ

upínací nářadí



clamping tools

M&V VELKOORCHOD
NÁSTROJI, NÁŘADÍM
A STROJÍ

M&V spol. s r. o.
ulice 4. května 288
755 01 VSETÍN